



REGENESIS[®]

**Sustainable PFAS Remediation:
the Environmental Impact of Enhanced
Attenuation using Colloidal Activated
Carbon**



How should we treat PFAS?

PFAS – have we been here before?

- >7000 species of PFAS?!
 - tetracontane (C₄₀H₈₂) has 62,491,178,805,831 possible structural isomers!
- Persistent
 - Heavy metals
 - Dioxins
 - PCBs
- Clean-up criteria in ppq!?

PFAS – Possible Future Groundwater Remediation Scenarios

- **Scenario 1:**
Use pump and treat or *in situ* injection/emplacement of sorbents at **all PFAS groundwater sites** needing plume control

We can't dig up
or dewater
Europe.

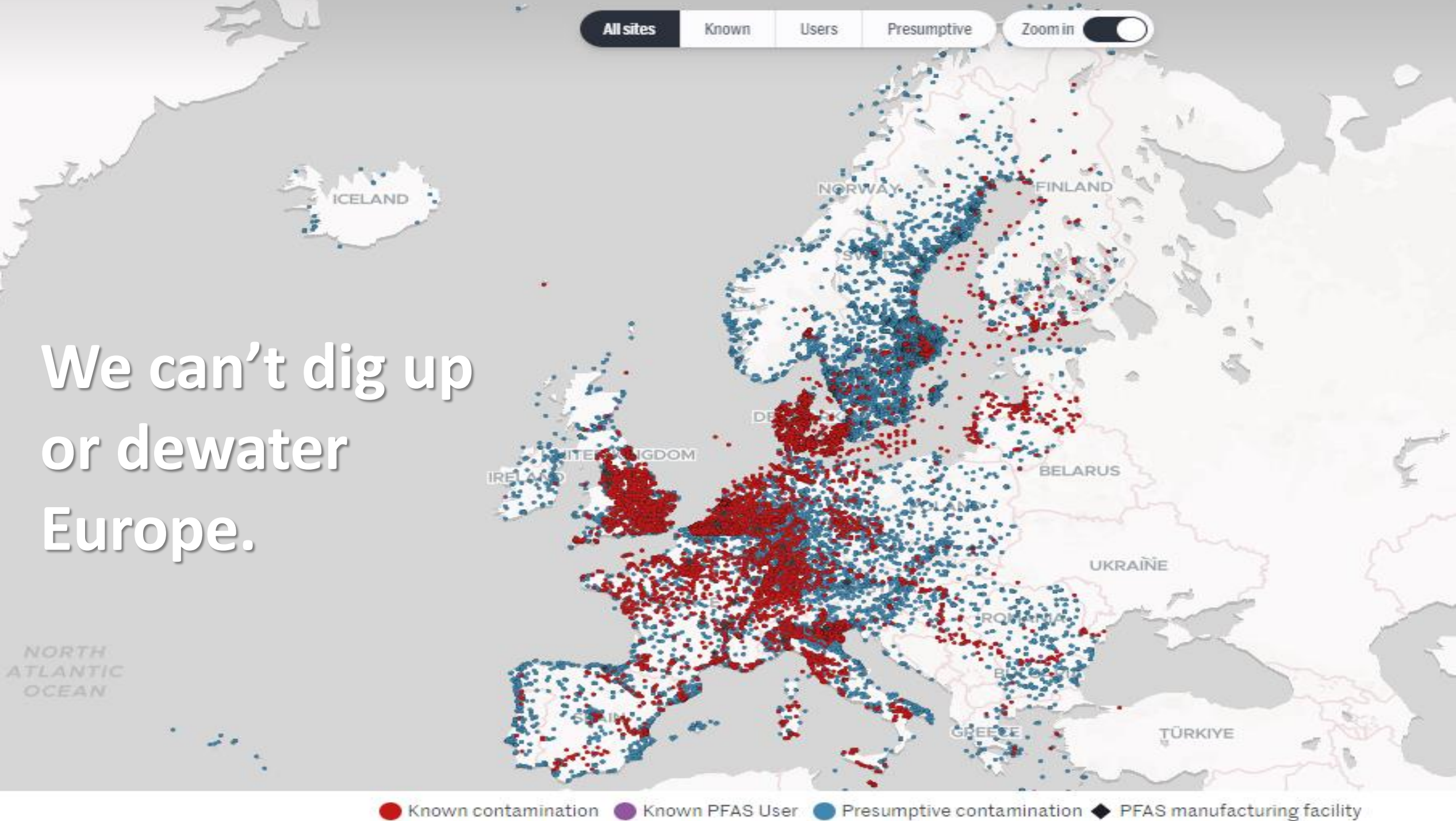

PFAS – Possible Future Groundwater Remediation Scenarios

- **Scenario 1:**

Use pump and treat or *in situ* injection/emplacement of sorbents at **all PFAS groundwater sites** needing plume control



- **Scenario 2:**

If "silver bullet" PFAS remediation technologies emerge

- Chlorinated solvent site remediation methods the early 2000s
- Still – so widespread; is it **really** going to be used everywhere?



- **Scenario 3:**

Implement triage approach:

- Point-of-use treatment for large sites
- Improved pump and treat
- Enhanced Natural Attenuation



How should we treat PFAS?

Adopt a sustainable remediation approach



Pumping huge volumes, Landfill,
Energy, Equipment, Transport, Cost
High ongoing carbon footprint

(ISO 18504:2017) definition:

Sustainable Remediation is the
'elimination and/or control of unacceptable risks in a safe and timely manner whilst optimizing the environmental, social and economic value of the work.'

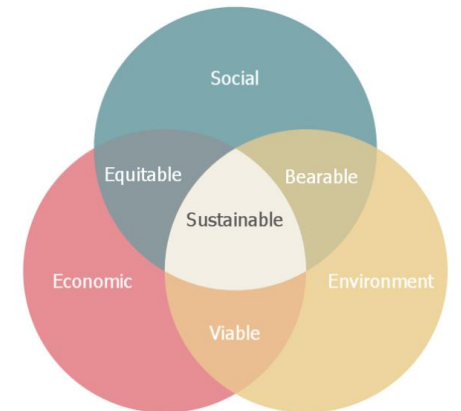

Enhanced Attenuation of PFAS?!

But some PFAS don't biodegrade?

Correct! (Maybe)

But Natural Attenuation doesn't just mean biological degradation:

- Diffusion
- Volatilisation
- Sorption ←
- Chemical (abiotic) degradation

The Interstate Technology and Regulatory Council (ITRC, 2008) defined EA as:

"Any type of intervention that might be implemented in a source-plume system to increase the magnitude of attenuation by natural processes beyond that which occurs without intervention. Enhanced attenuation is the result of applying an enhancement that sustainably manipulates a natural attenuation process, leading to an increased reduction in mass flux of contaminants."

Increase the ability of the aquifer to sorb PFAS ('retention')
=Enhanced Attenuation of the PFAS plume

Enhanced Natural Attenuation of PFAS?

Peak Shaving and Hysteretic Retention...

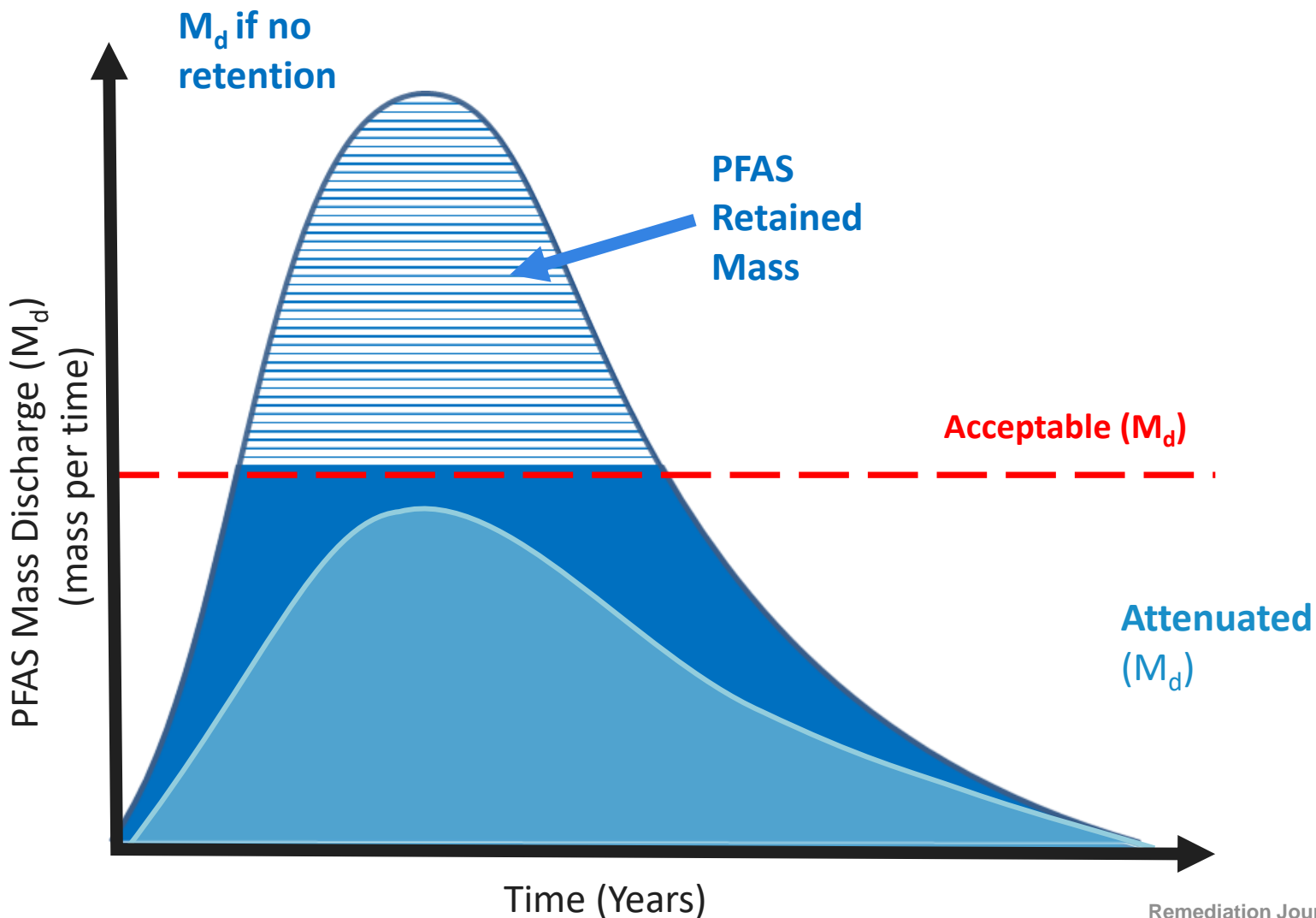

Peak Shaving:

Following source treatment and the application of colloidal activated carbon, the plume will be subject to “hysteretic” retention processes:

- *Fast sorption* and slow desorption



- **Result:** decrease the mass discharge of the plume
- Spreading it out over a longer period
 - known as **Peak Shaving**

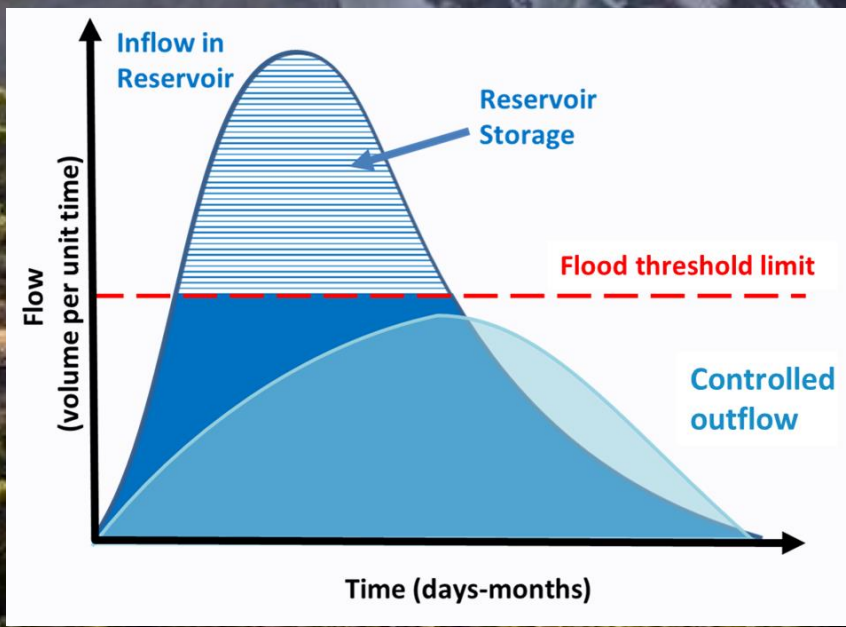

Enhanced Natural Attenuation of PFAS – Sequestration

Expectations

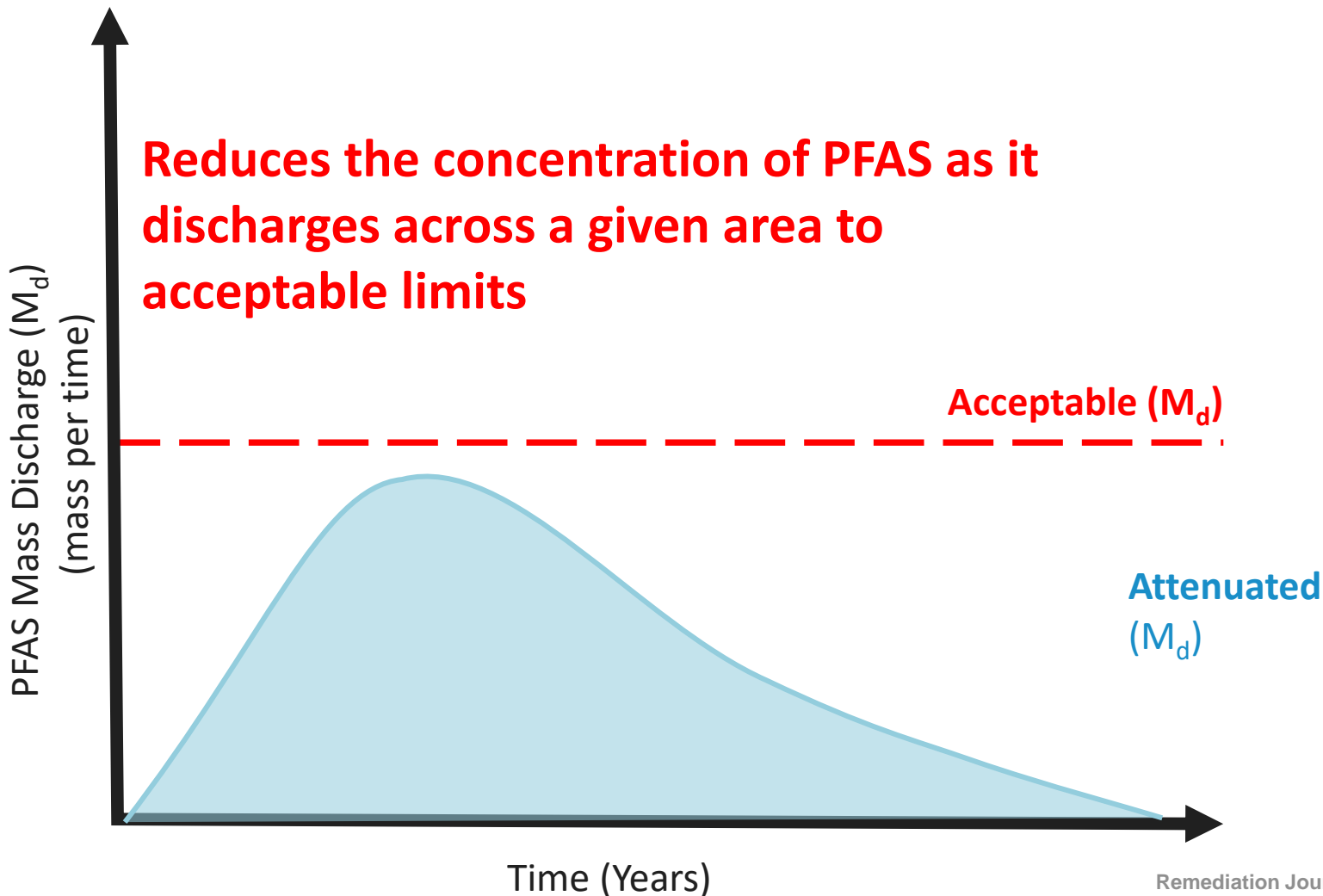

- No breakthrough if the source has been sufficiently treated
- Never significant breakthrough for low flux plumes where source treatment is not possible

Enhanced Attenuation





DOI: 10.1002/rem.21731

RESEARCH NOTE

WILEY

Enhanced attenuation (EA) to manage PFAS plumes in groundwater

Charles J. Newell¹  | Hassan Javed¹ | Yue Li¹ | Nicholas W. Johnson²  | Stephen D. Richardson³ | John A. Connor¹ | David T. Adamson¹

¹GSI Environmental Inc., Houston, Texas, USA

²GSI Environmental Inc., Folsom, California, USA

³GSI Environmental Inc., Austin, Texas, USA

Correspondence

Charles J. Newell, GSI Environmental Inc., Houston, TX, USA.
Email: cjnewell@gsi-net.com

Funding information

GSI Environmental

Abstract

Remediation of per- and polyfluoroalkyl substances (PFAS) in groundwater is particularly challenging because of their unique chemical and fate and transport properties. Many conventional in-situ remediation technologies, commonly applied to address other groundwater contaminants, have proven ineffective for treatment of PFAS. Given their stability, destruction of PFAS in-situ has remained elusive as an in-situ treatment option. Consequently, new approaches to manage PFAS groundwater plumes are of great interest to environmental practitioners. We propose that enhancing PFAS retention can play an important role in reducing PFAS mass flux and providing long-term protection of downgradient groundwater receptors. Enhanced retention of PFAS fits directly into the enhanced attenuation (EA) framework, an established groundwater remediation strategy that was developed in the first decade of the 2000s for other groundwater contaminants. In this paper, we propose eight EA approaches for PFAS in groundwater, including technologies that are currently being implemented at PFAS sites (e.g., injection of particulate carbon amendments), applications of conventional remediation technologies to PFAS sites (e.g., capping to retain PFAS in the vadose zone), and novel, innovative approaches (e.g., intentional food grade LNAPL emplacement to retain PFAS) for enhanced PFAS retention. These EA approaches leverage the properties of PFAS to (i) facilitate sorption to conventional and novel sorbents, (ii) concentrate PFAS at air/water interface via gas sparging, and/or (iii)

Colloidal Activated Carbon and PFAS

Colloidal Activated Carbon

What Is It?

- Liquid **activated carbon**
 - Particle sizes 1 – 2 μm
- Suspended as a **colloid** in a polymer solution
- **Distributes widely** under low pressure
 - No high-pressure fracturing is needed
- Provides **extremely fast sorption sites**
 - Converts underlying geology into purifying filter
- Does not “washout” of the aquifer
- Is **non-toxic**



CAC: Reduces Risk of PFAS

- ~~Risk = Hazard x Exposure~~
- CAC binds up PFAS *in situ*
- Reduces potential for downgradient exposure
- Reduces the risk



Considering the PFAS Source-Plume System

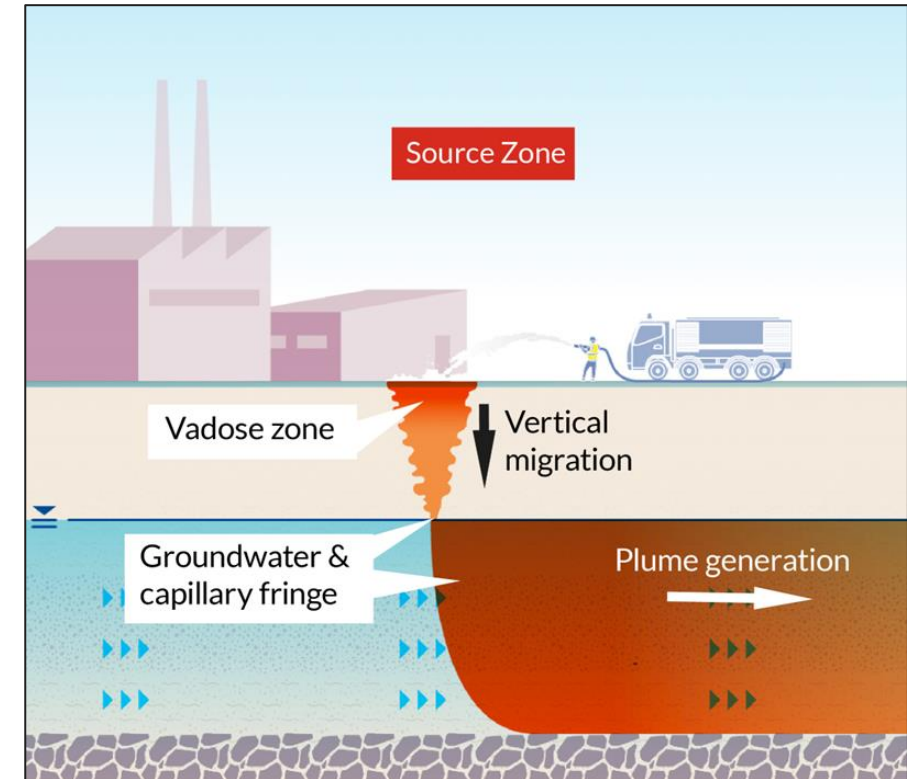
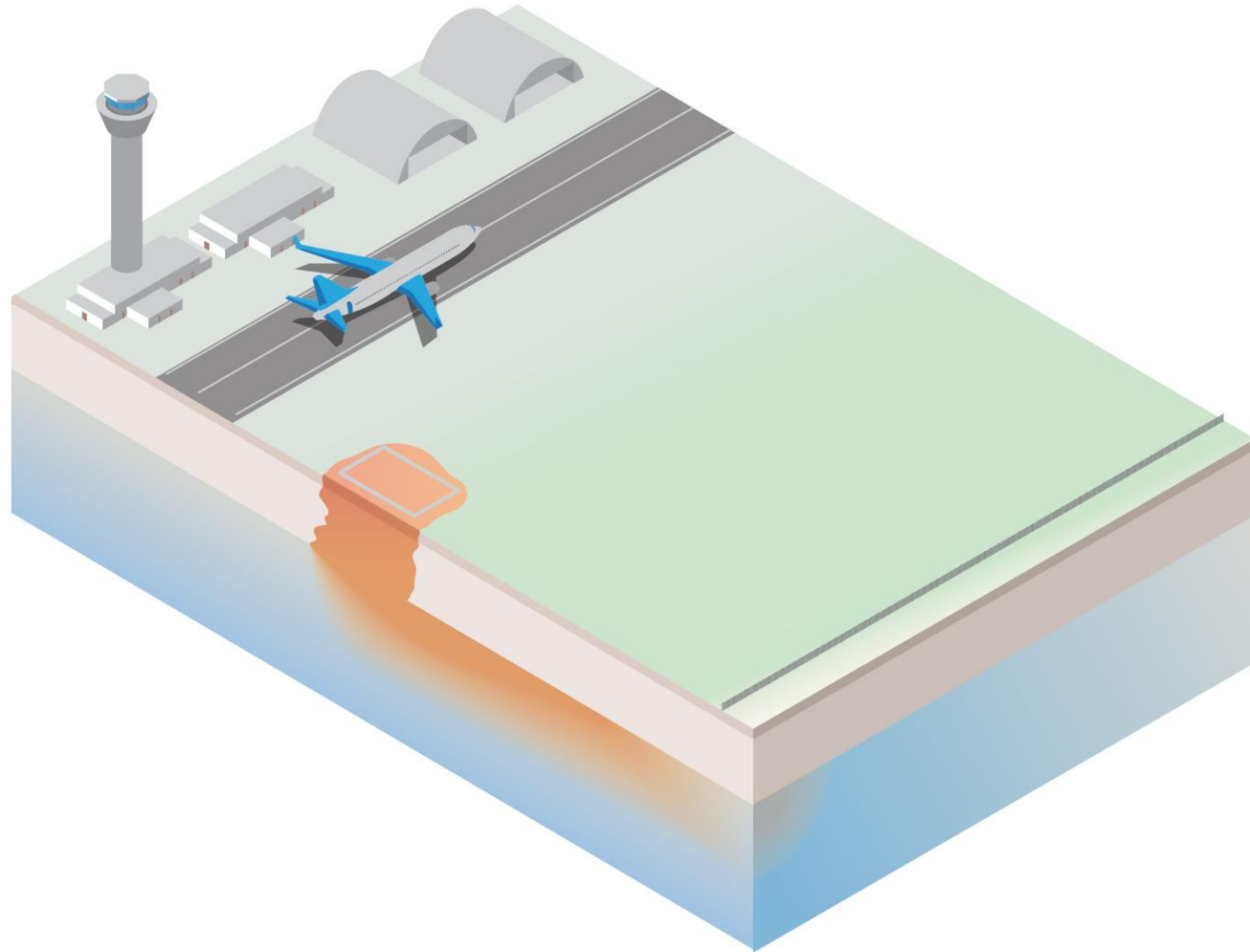

Considering the PFAS Source-Plume System

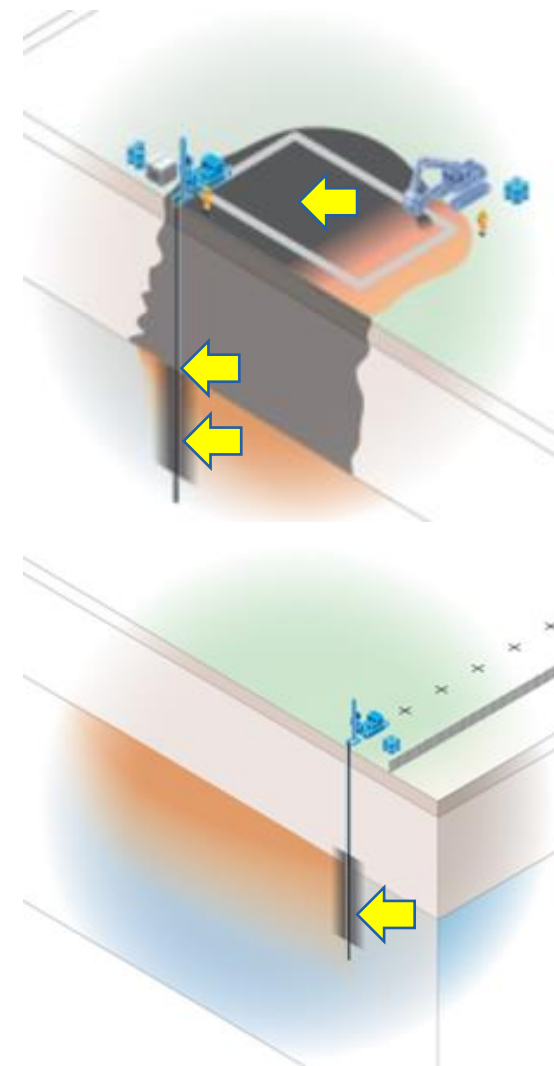
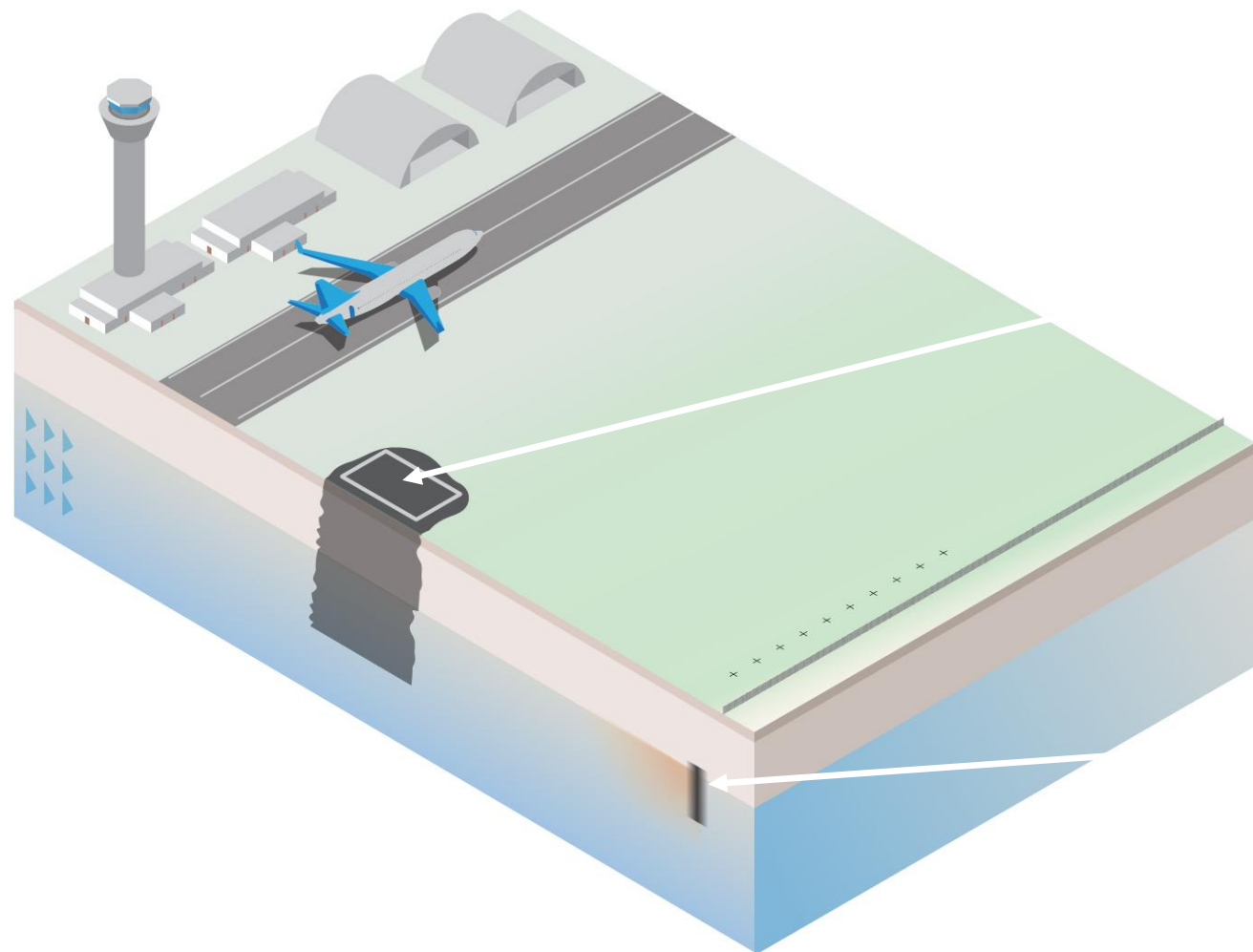

Source Treatment = Enhanced Attenuation Combine With Plume Treatment = Rapid Risk Removal

SourceStop™

PLUME STOP
Liquid Activated Carbon

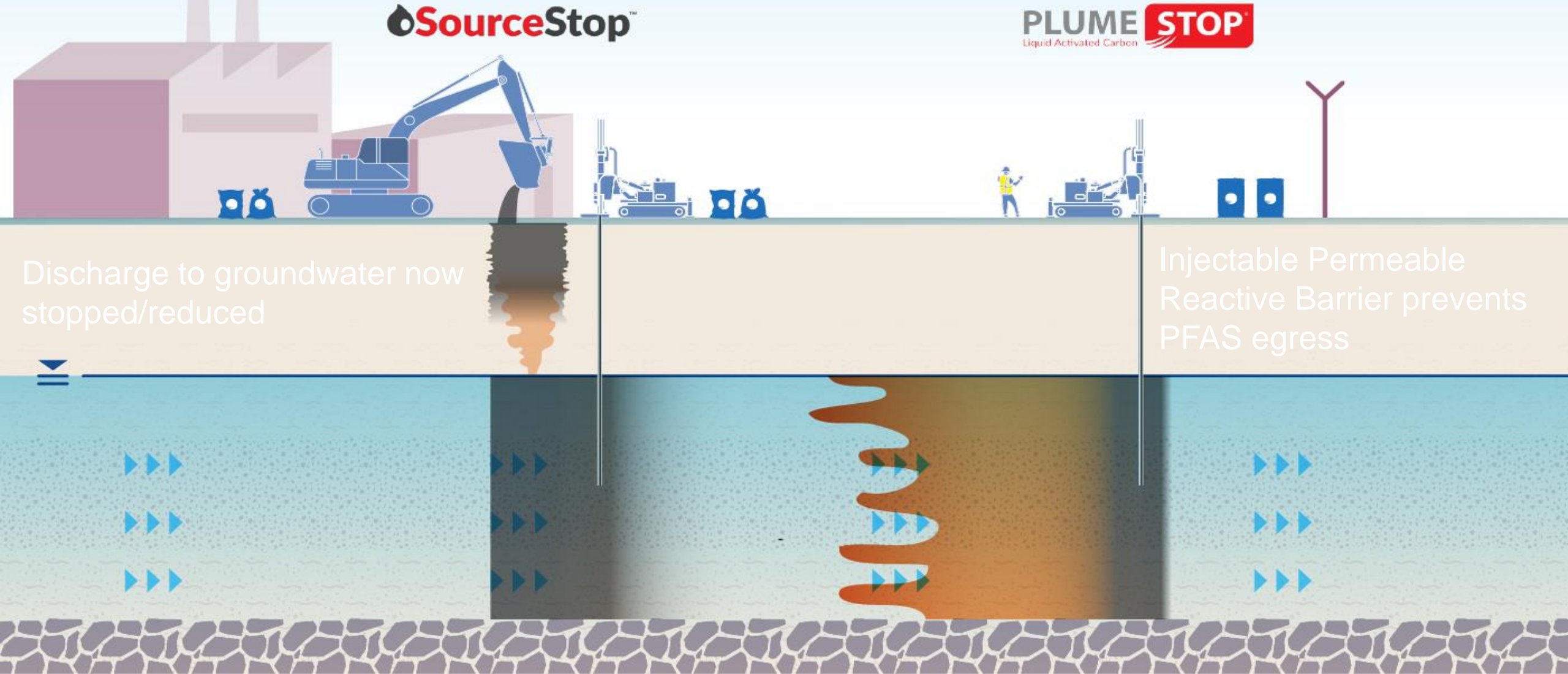

PlumeStop: Proven on PFAS Sites Worldwide

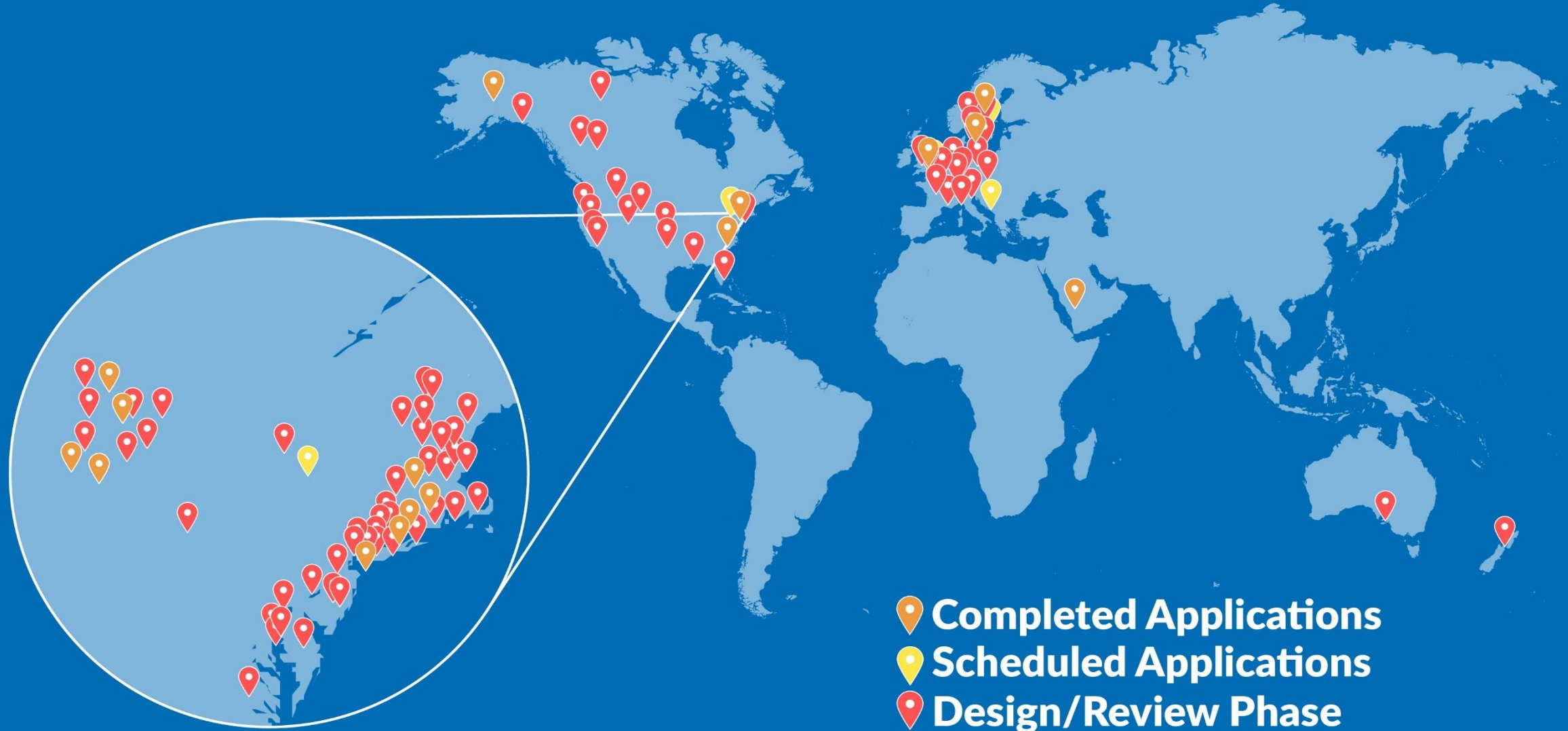

Case Studies





UK International Airports

6-Month PFAS Pilot Trial

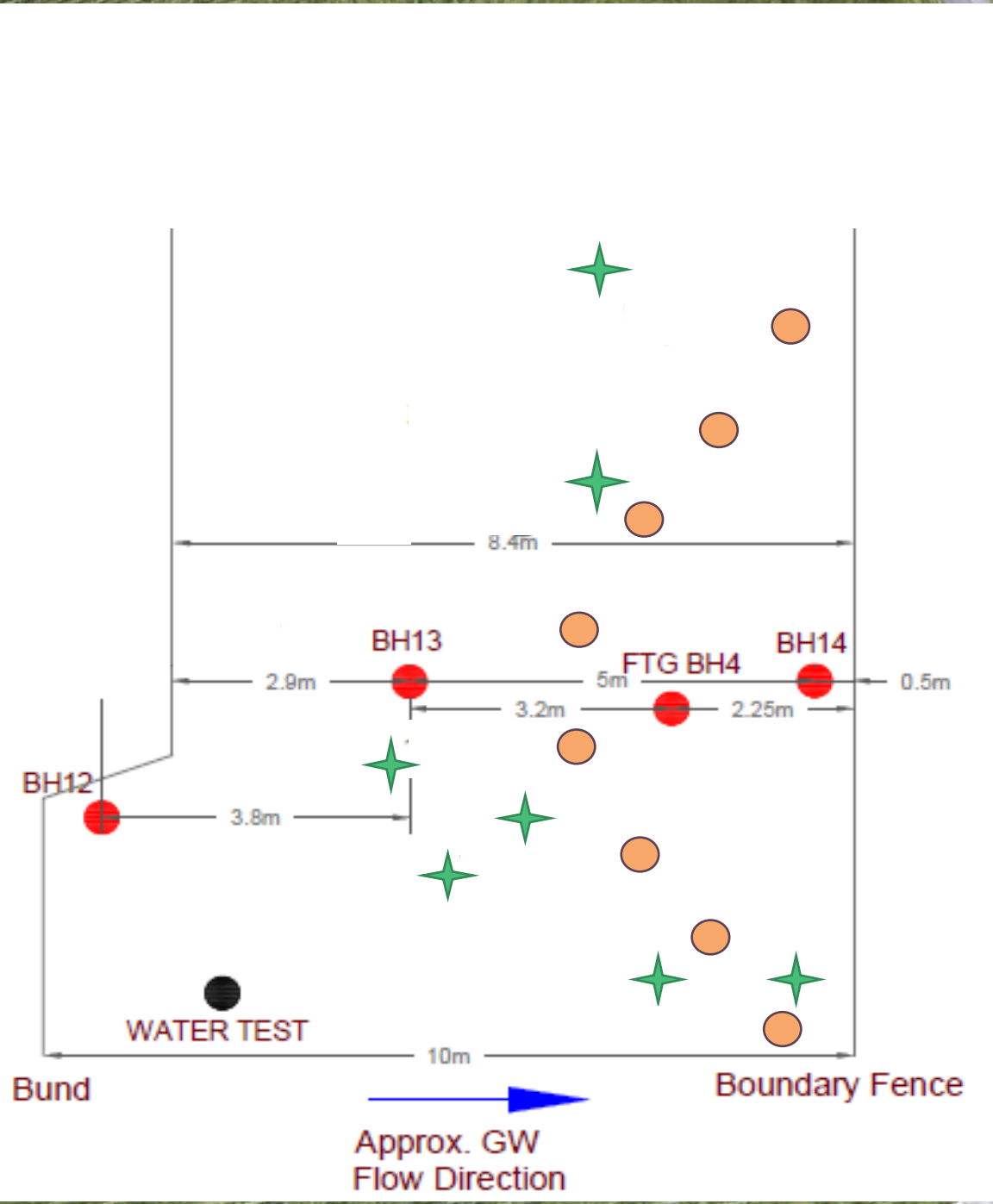
Full-Scale Results





-  PlumeStop Injection
-  Monitoring Well
-  Parking Agent Injection
-  Radius of Influence Test



Results

Project goal: 'betterment' approx. >90% reduction in target contaminants PFOS and PFOA

PFOA/PFOS reduced to < detection limits

96-99% reduction in SUM24 PFAS

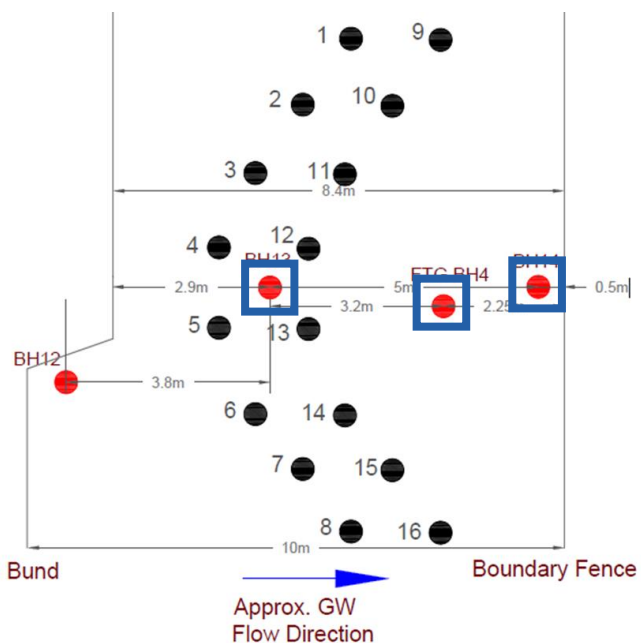

Main and Target PFAS Compounds

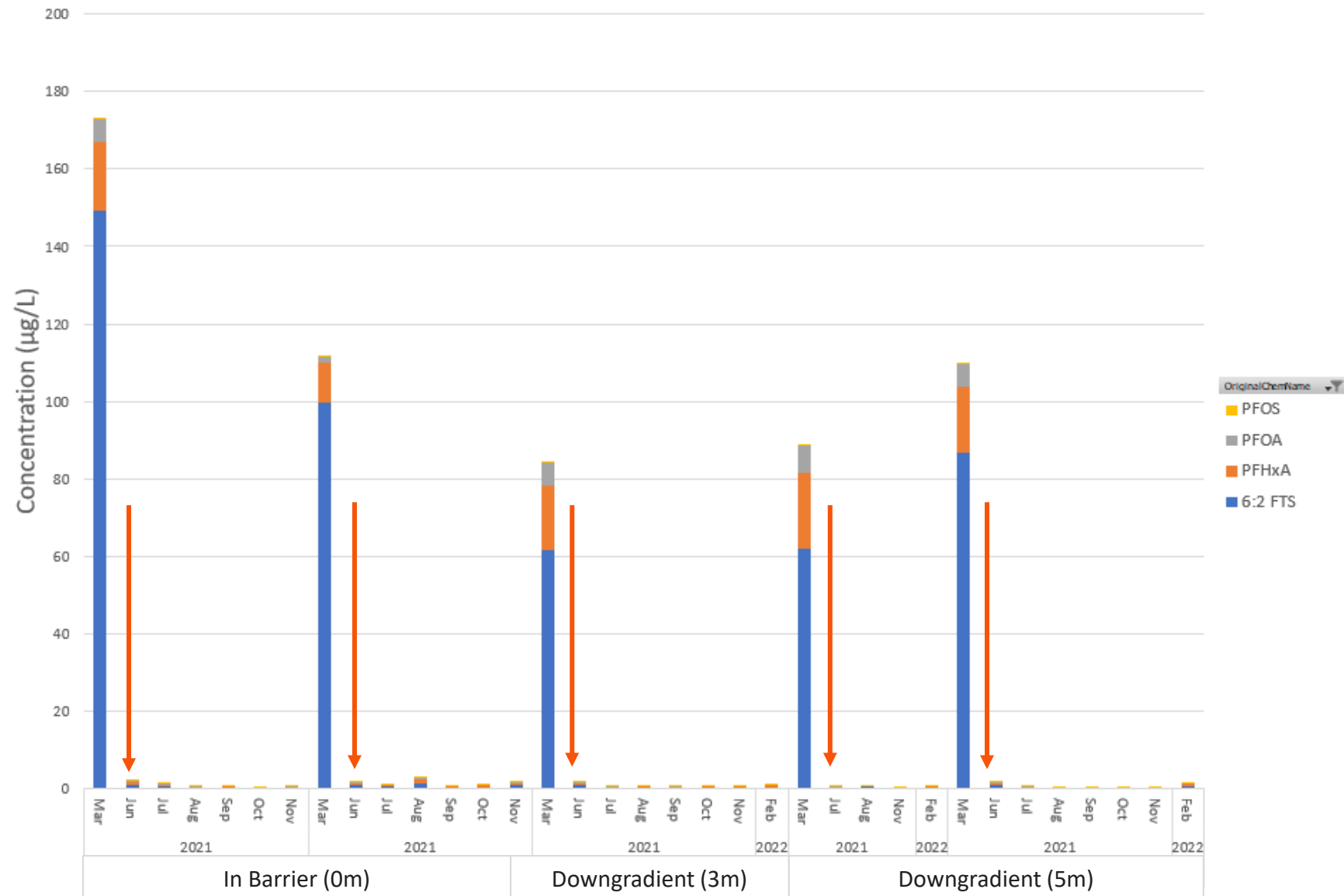

Full-Scale Barrier

104 no. injection points

76m extension of barrier

2x upgradient monitoring locations

4x in "barrier wells"

6x downgradient monitoring locations

PetroFix barrier

Parking agent



Is the concept credible?	Can it work in practice?	Is the science sound?	Has the hypothesis been tested?	Are the results repeatable?

Sustainability Comparison

Overview of Study

Ramboll

- Head of Circular Solutions and Climate Specialist team, Finland

PFAS Contaminated Airport, UK

- Immediately prevent/reduce offsite PFAS migration
- Source treatment to follow

Compare the Life Cycle Analysis for:

- **In Situ Sorption and Retention Barrier**
 - Passive barrier of colloidal activated carbon (PlumeStop)
 - Recently implemented at the site
- **Ex Situ Pump and Treat**
 - Utilized granular activated carbon (GAC)
 - Theoretical, best-practice design

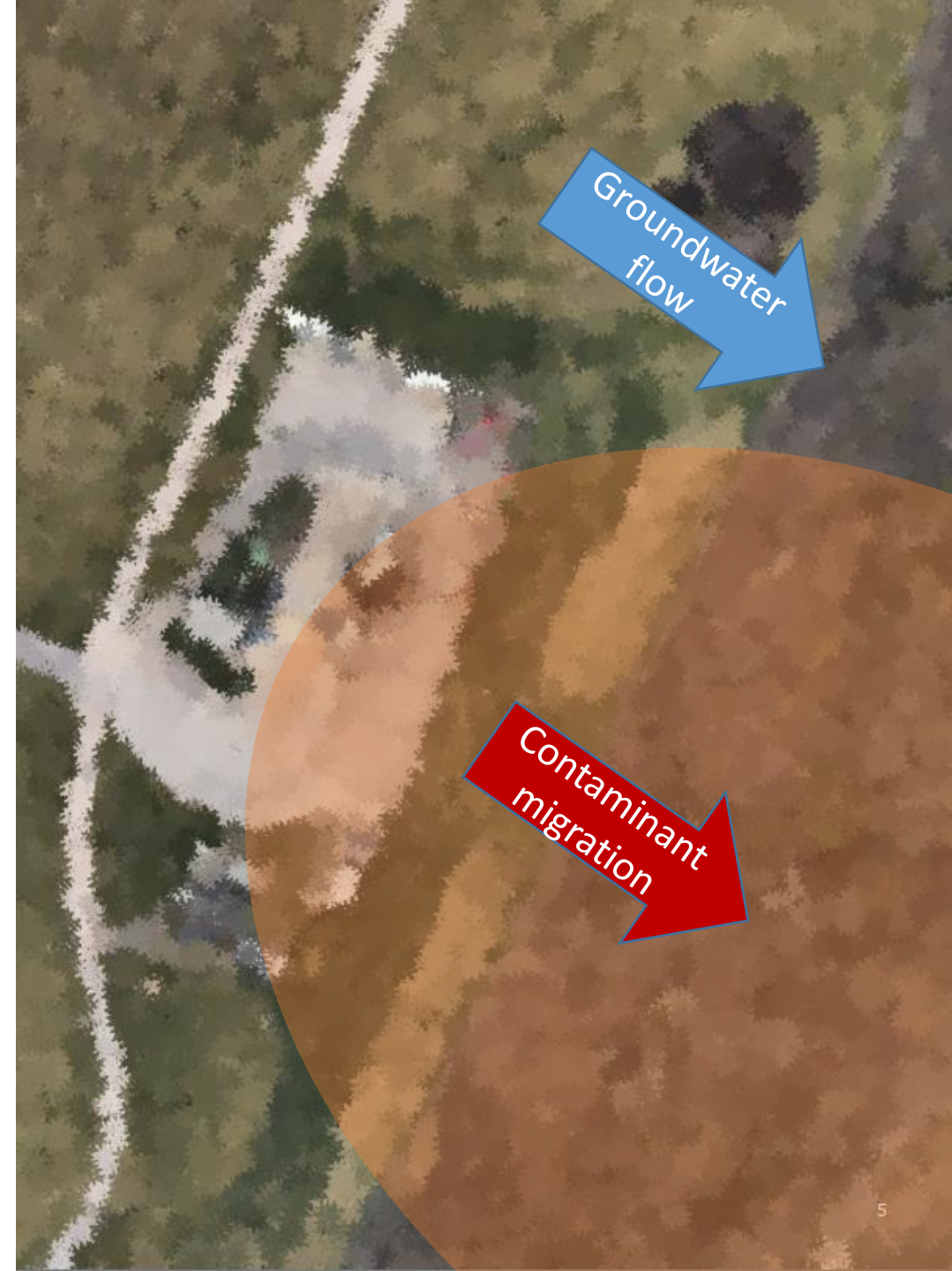

Life Cycle Inventory Analysis

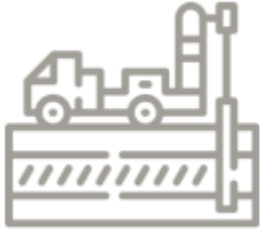

Immobilization with PlumeStop®

- Single injection round is scheduled.
- The design guarantees a minimum of 15 years of efficacy.
- There are 102 injection points.
- The length of the operation area is approximately 110 meters.
- A total of 33,566 kilograms of PlumeStop is used.
- 1,590 liters of fuel is consumed for the injection process.
- There are 3 monitoring wells, each approximately 10 meters deep.
- Environmental monitoring takes place twice a year.

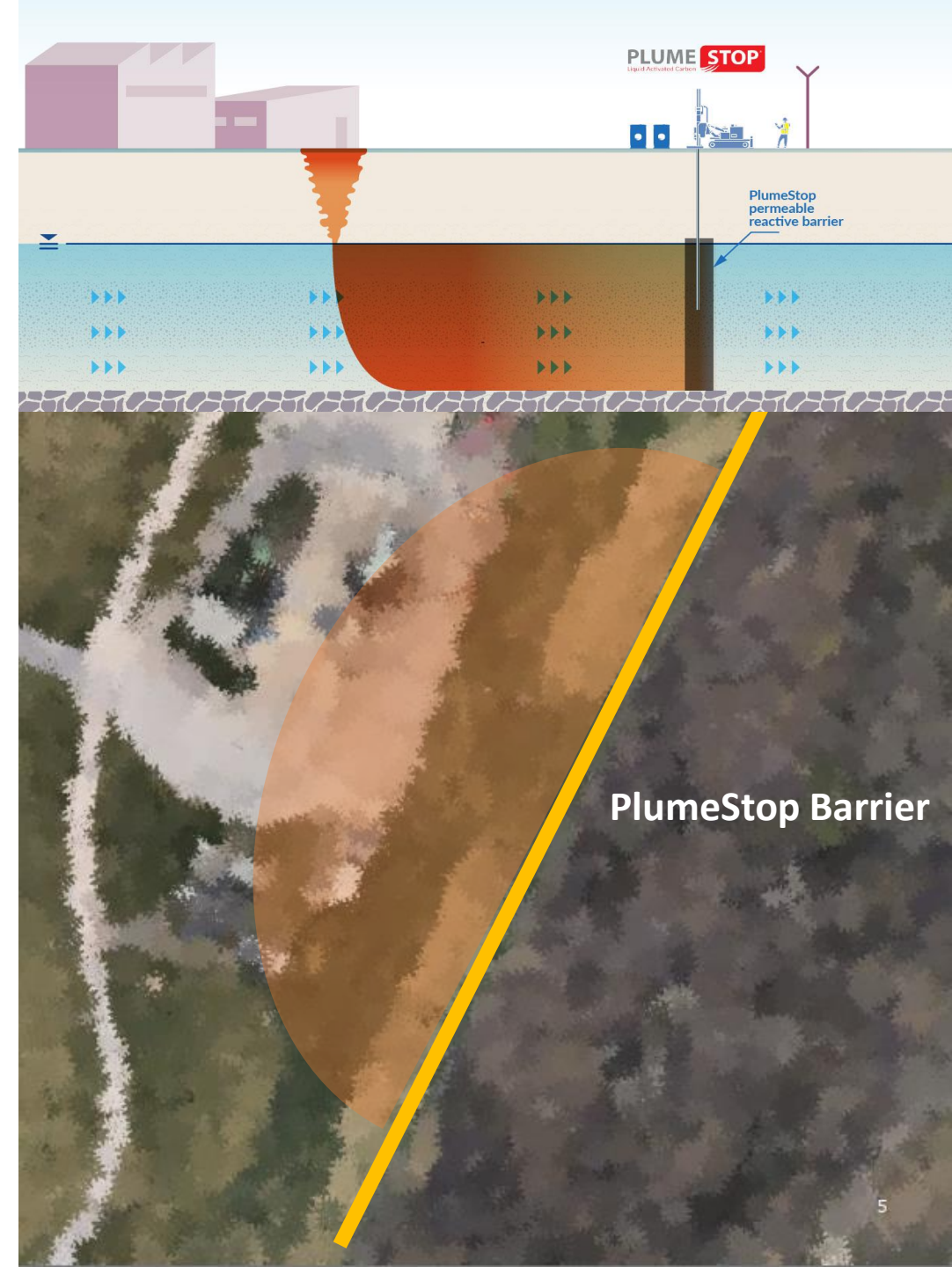

Scope of Assessment: Cradle to Grave

Methods/Software

- ISO 14040:2006, ISO 14044:2006, ISO 14067:2018, PCR for Basic Chemicals
- GaBi 10 Professional, Sphera, Ecoinvent 3.8

System boundary



In situ: PlumeStop



Life Cycle Inventory Analysis

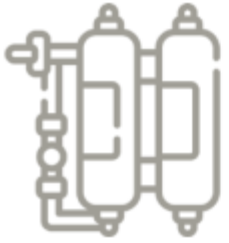

Pump & Treat with
GAC filtration

- Consensus achieved from 3 P&T designers.
- Fixed equipment installation is planned.
- Continuous operation for 15 years with a 95% uptime.
- There are 8 extraction wells, each approximately 8 meters deep.
- The design is to avoid excess draw-down resulting in vertical spread/smear.
- The pumping rate is about 98 liters per minute.
- The usage rate of GAC is approximately 24,040 kilograms per year.
- The adsorption capacity is 100 milligrams per kilogram.
- The electricity consumption is 960,000 kWh per year.
- Office O&M inspections occur 4 times per year.
- Around 1,590 liters of fuel is used for the installation process.
- There are 3 monitoring wells, each approximately 10 meters deep.
- Environmental monitoring takes place twice a year.

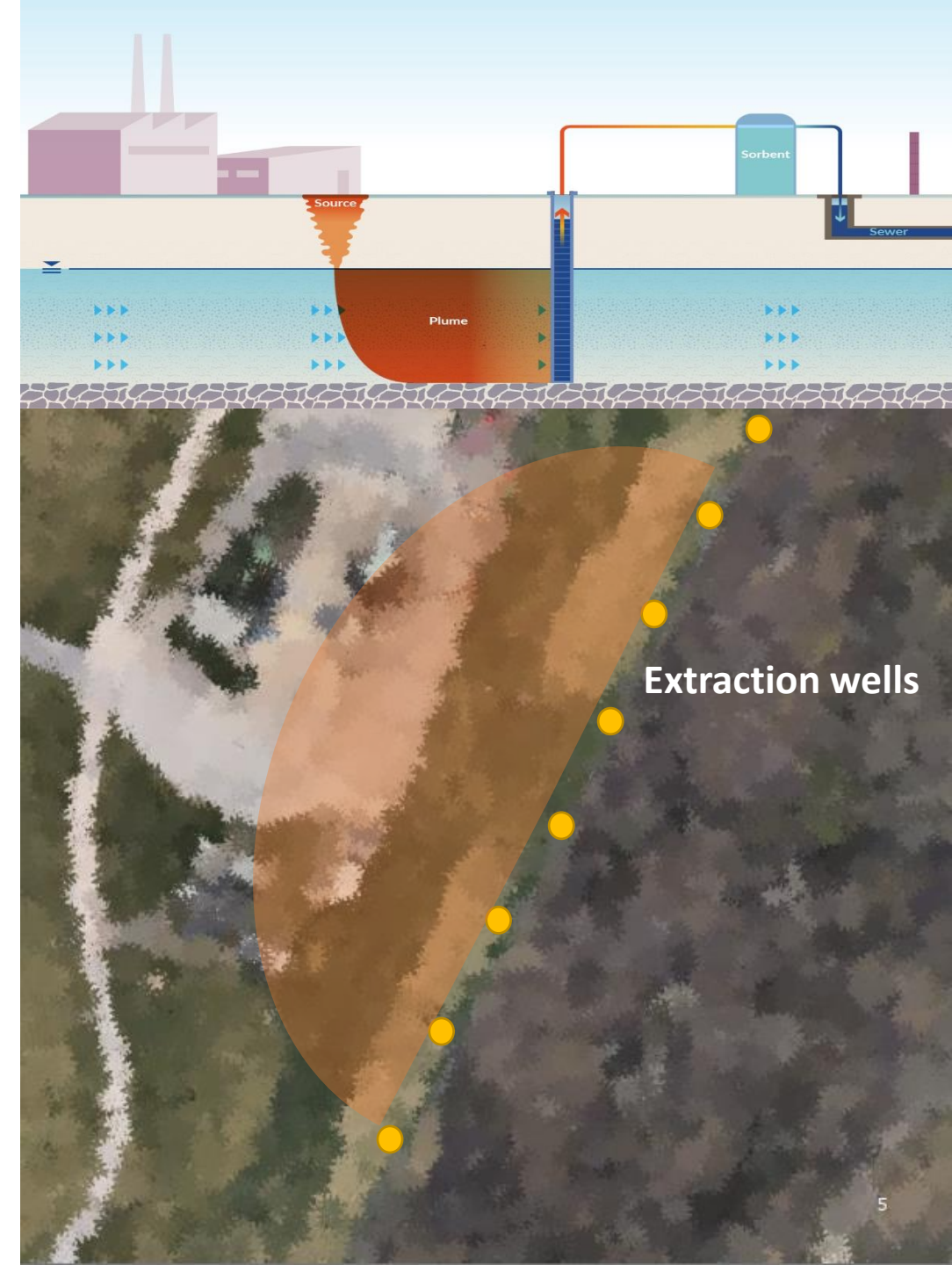

Scope of Assessment: Cradle to Grave

System boundary

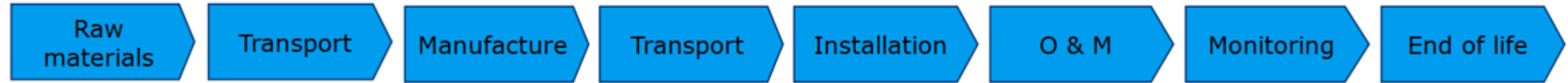

On-site: Pump & Treat



In situ: PlumeStop



Methods/Software

- ISO 14040:2006, ISO 14044:2006, ISO 14067:2018, PCR for Basic Chemicals
- GaBi 10 Professional, Sphera, Ecoinvent 3.8

Carbon Footprint

Total Carbon Footprint: P&T vs Treatment In-Place

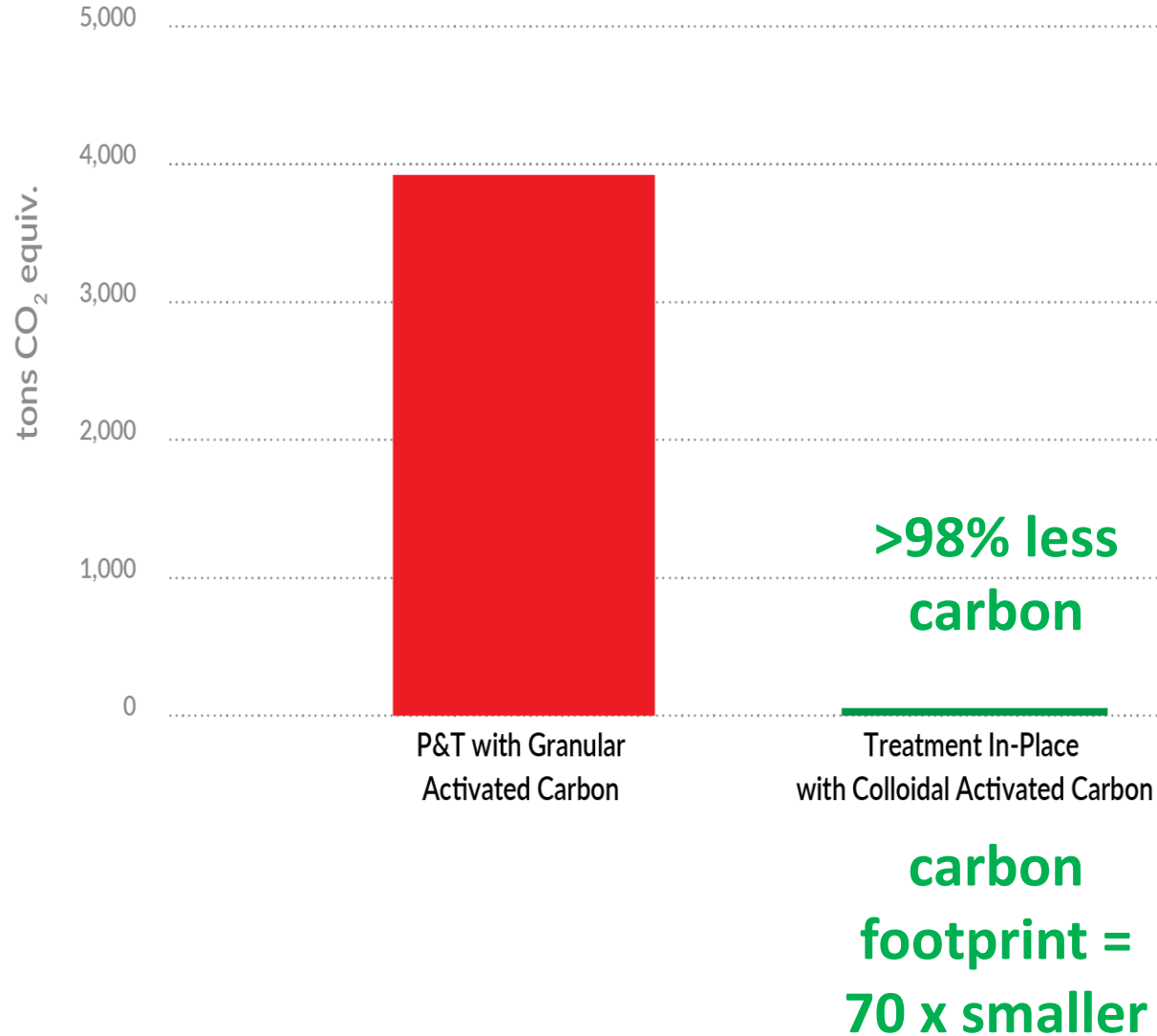

	PlumeStop	P&T w/ GAC
Remediation equipment		15,2
Civil works		
Fixed installations	0,05	0,9
Machinery	1,0	1,3
Remediation and operations		
PlumeStop / GAC	50,5	2 860
Electricity		281
Maintenance		3,6
Monitoring	4,0	4,0
Waste management		
Hazardous waste		112
Wastewater treatment		644
Total carbon footprint	56	3 922

Carbon Footprint

- GAC footprint most significant impact
- Assumes landfill
 - Incineration in future
 - Will increase impact
- Options to reduce or remove GAC?

	PlumeStop	P&T w/ GAC
Remediation equipment		15,2
Civil works		
Fixed installations	0,05	0,9
Machinery	1,0	1,3
Remediation and operations		
PlumeStop / GAC	50,5	2 860
Electricity		281
Maintenance		3,6
Monitoring	4,0	4,0
Waste management		
Hazardous waste		112
Wastewater treatment		644
Total carbon footprint	56	3 922

Carbon Footprint

We also modelled Foam Fractionation (FF):

- Bubble/skim off PFAS
- Reducing GAC
- Increasing equipment/electricity

Total Carbon Footprint

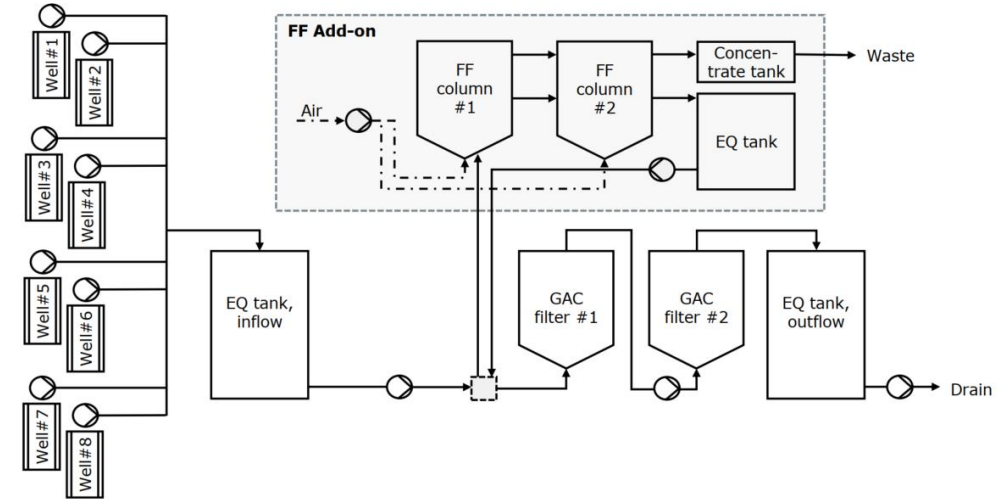
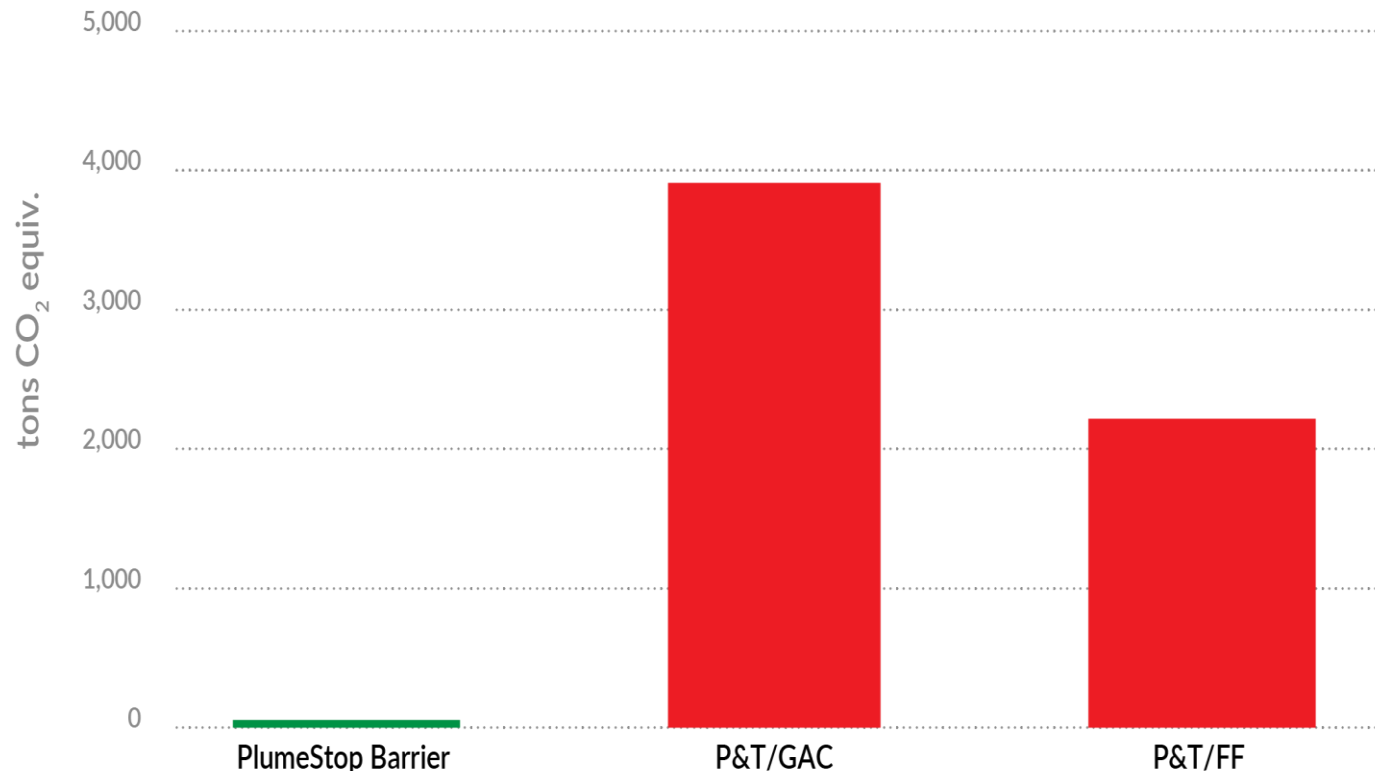

- In situ retention still 97.5% lower (carbon footprint = 40 x smaller)
- Changing treatment ≠ significant reduction
- Pumping alone = 1-2 Orders Of Magnitude increase in Carbon Footprint
- ANY filtration or destructive treatment technique only adds to this

Life Cycle Cost Analysis

- Pricing analysis by Ramboll
- Based on a 15-year treatment
- Costs at different times throughout
- Net Present Value:

CAC retention barrier = \$1.608M

P&T with GAC = \$4.039M

P&T with FF = \$4.623M

Breakdown of Life Cycle Cost for Remediation

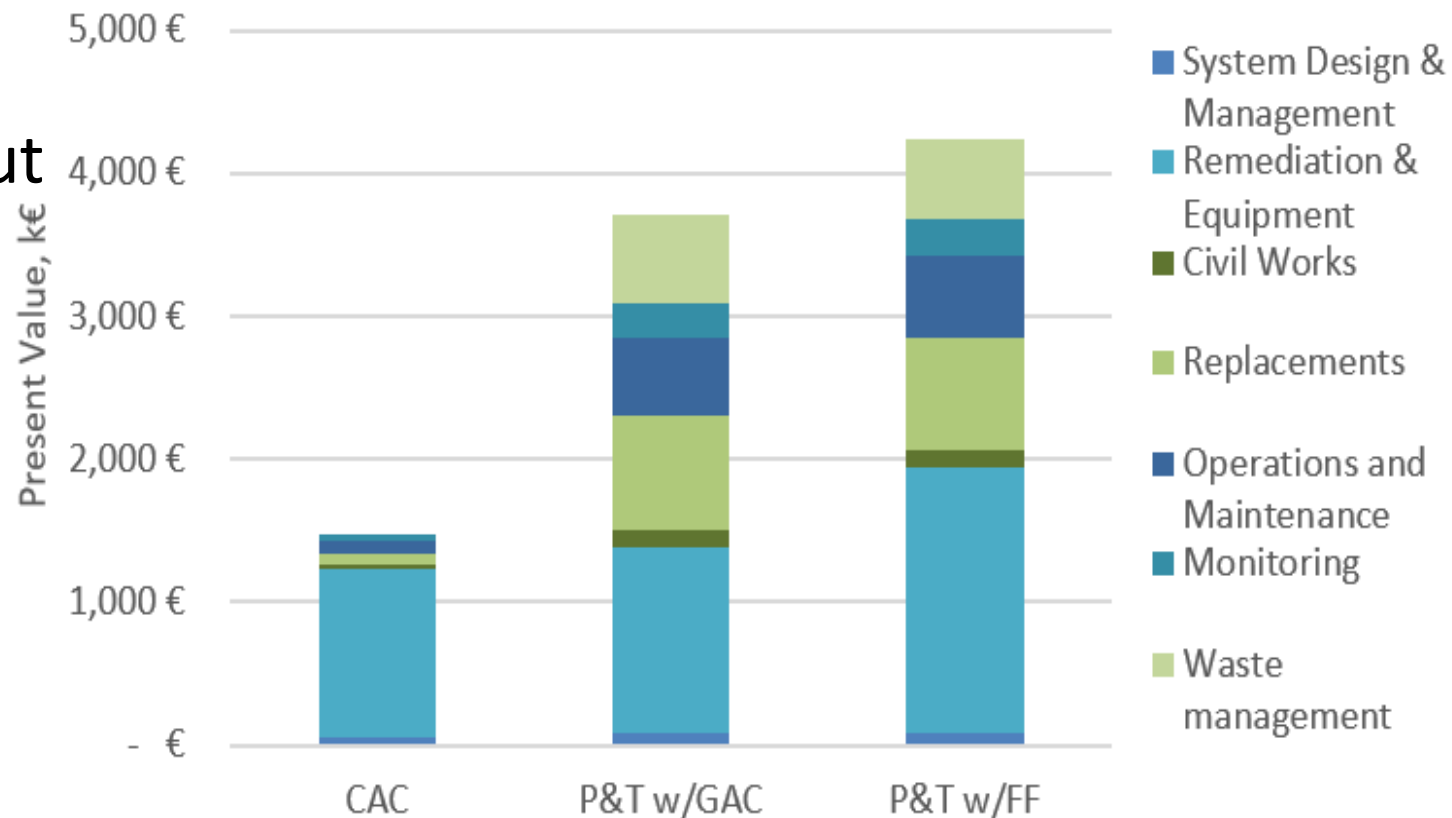

61-65%
less

Reviewing other impact factors

- A 'Tier 2' sustainability assessment was completed by using SURE by Ramboll (SURE).
- SURE is based on standards from ISO and ASTM, and aligned with the Sustainable Remediation Forum (UK) guidance.
- Linear-additive multi-criteria analysis (MCA) method and is designed to incorporate both qualitative and quantitative information.
- 15 sustainability indicators encompassing each sustainability domain weighted and scored
- Comparison remedial options

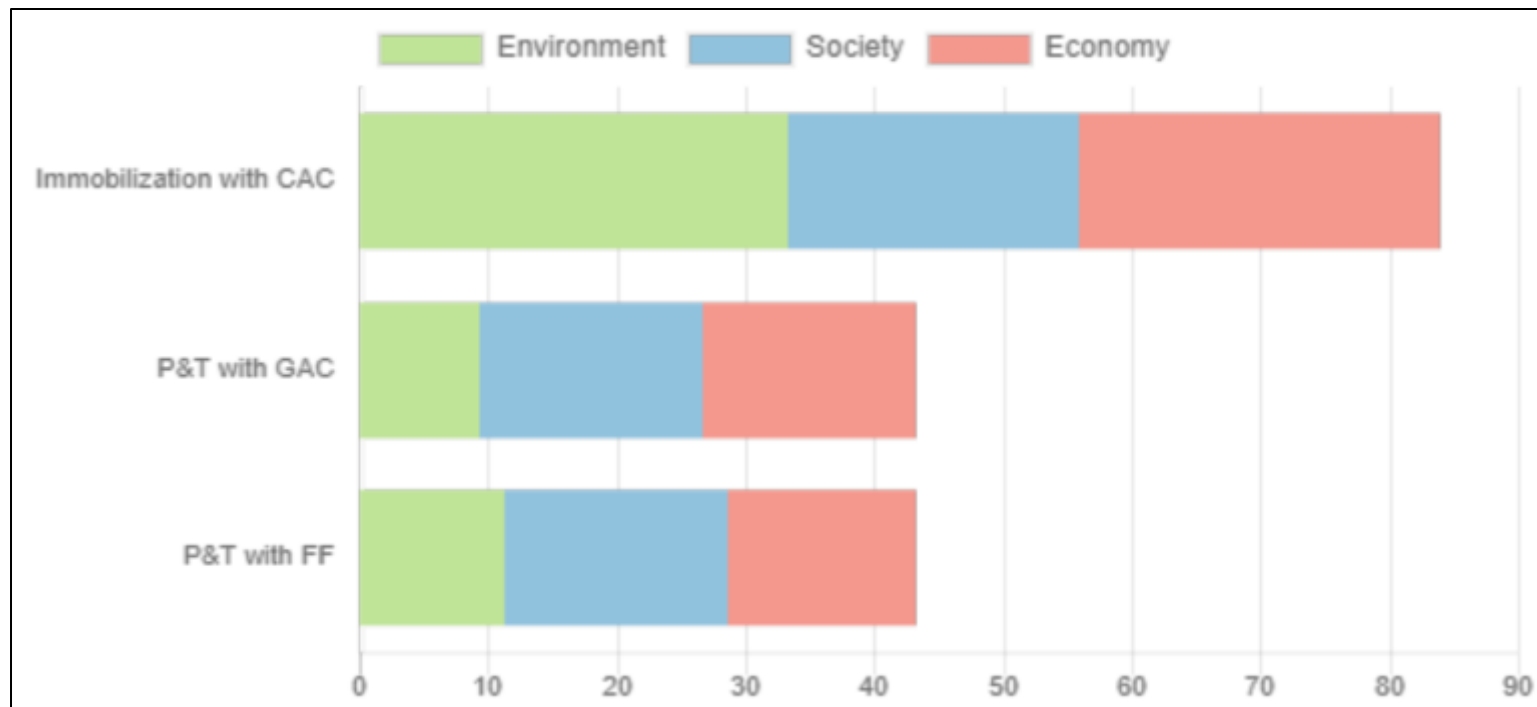

Conclusion

- Remediation of a PFAS site should consider sustainability
 - A way of ensuring the site is not managed in isolation
- Pump & Treatment has a carbon footprint for both components
 - Pumping alone has a MUCH higher impact than in situ treatment
 - ANY ex-situ Treatment will add to that impact
- Enhanced attenuation of PFAS through retention by CAC injection
 - Effective and Sustainable approach to address a global pollution issue

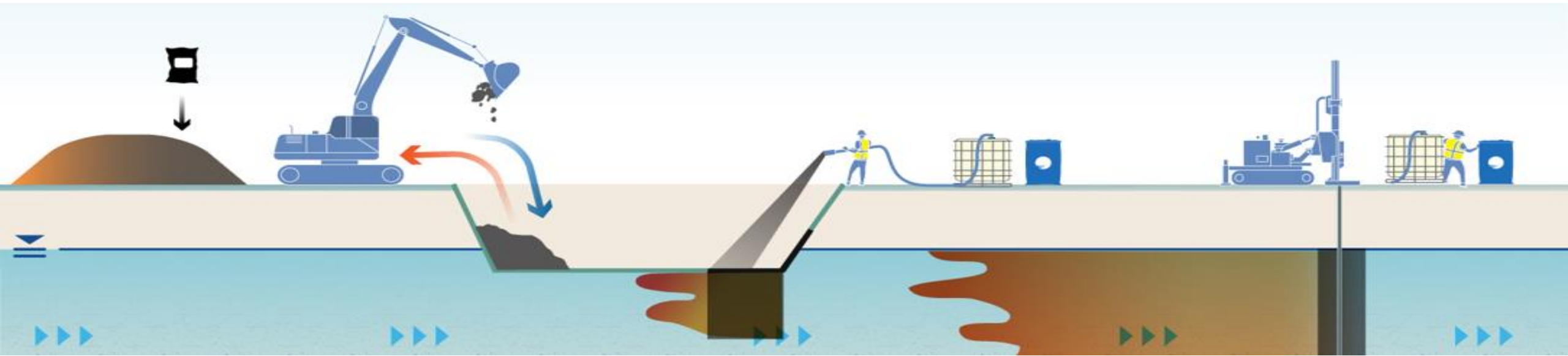

Treat soil source: *In situ* leachability and infiltration treatment

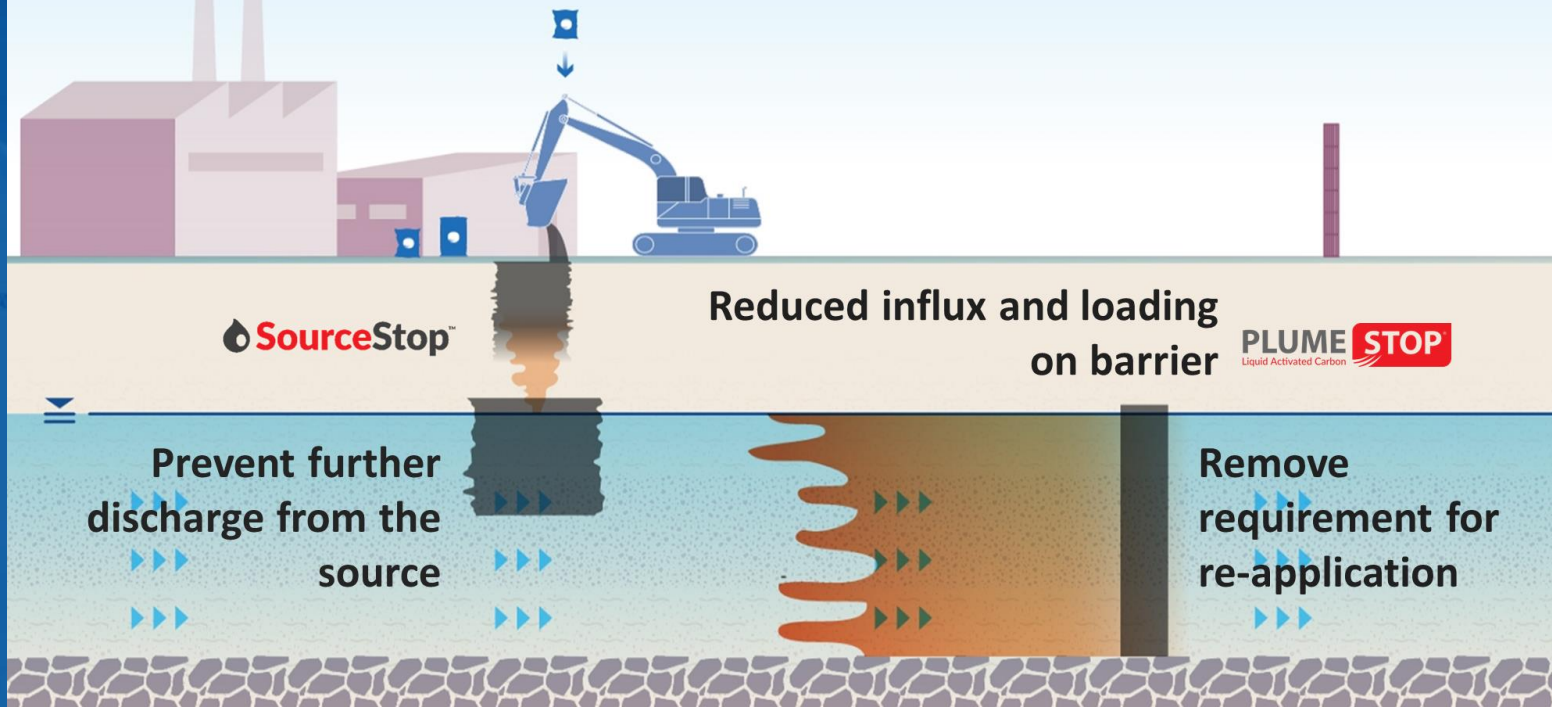

Jack Shore

Senior District Manager, UK and Scandinavia
REGENESIS

jshore@regenesisis.com

+44 7720 633930



Jack Shore

UK & Scandinavia District
Manager at REGENESIS



Connect with LinkedIn